

## What are National Occupational Standards (NOS)?

- NOS describe what individuals need to do, know and understand in order to carry out a particular job role or function
- NOS are performance standards that individuals must achieve when carrying out functions in the workplace, together with specifications of the underpinning knowledge and understanding

### Contact Us:

IT-ITeS SSC NASSCOM

E-mail:

ssc@nasscom.in



## Contents

1. Introduction and Contacts..... P.1
2. Qualifications Pack ..... P.2
3. Glossary of Key Terms ..... P.3
4. NOS Units..... P.5
5. Nomenclature for QP and NOS Units ..... P.21
6. Criteria for Assessment of Trainees ..... P.23

## Introduction

### Qualifications Pack-Domestic IT Helpdesk Attendant

**SECTOR:** IT-ITES

**SUB-SECTOR:** IT Services

**OCCUPATION:** IT Support Services/Helpdesk

**REFERENCE ID:** SSC/Q0110

**ALIGNED TO NCO CODE:** TBD

**Domestic IT Helpdesk Attendant** in the IT-ITeS Industry is also known as a Helpdesk Executive, Service Desk Executive, Technology Support Executive, IT Support Executive, Helpdesk Coordinator.

**Brief Job Description:** Individuals at this job are mainly responsible for the smooth running of computer systems and ensuring users get maximum benefits from them. Individual tasks vary depending on the size and structure of the organization, but may include installing and configuring computer hardware operating systems and applications; monitoring and maintaining computer systems and networks; talking staff/clients through a series of actions, either face to face or over the telephone to help set up systems or resolve issues; troubleshooting system and network problems and diagnosing and solving hardware/software faults etc.

**Personal Attributes:** This job requires the individual to have thorough knowledge of various technology trends and processes as well as have updated knowledge about IT initiatives. He/she should be highly motivated and energetic with the ability to self-direct daily activities.

Job Details	Qualifications Pack Code	SSC/Q0110		
	Job Role	Domestic IT Helpdesk Attendant		
	Credits (NSQF)	TBD	Version number	1.0
	Sector	IT-ITeS	Drafted on	30/04/2013
	Sub-sector	IT Services	Last reviewed on	31/01/2015
	Occupation	IT Support Services/ Helpdesk	Next review date	31/03/2016

Job Role	<b>Domestic IT Helpdesk Attendant</b> (Customer Service Associate, Customer Service Representative, Customer Care Executive, Technical Support, Helpdesk Coordinator, Process Associate- Voice)
Role Description	Managing and resolving client queries / issues primarily through telephonic calls.
NSQF level	4
Minimum Educational Qualifications	12 <sup>th</sup> preferable
Maximum Educational Qualifications	Master's Degree in any discipline
Training (Suggested but not mandatory)	Training programs in customer orientation, dealing with difficult customers, Telephone etiquettes etc.
Experience	0-1 year of work experience/internship in a related area
Applicable National Occupational Standards (NOS)	<p><b>Compulsory:</b></p> <ol style="list-style-type: none"> <li><a href="#">SSC/N0220 (Deal directly with IT service requests/incidents)</a></li> <li><a href="#">SSC/N9001 ( Manage your work to meet requirements)</a></li> <li><a href="#">SSC/N9003 (Maintain a healthy, safe and secure working environment)</a></li> </ol> <p><b>Optional:</b> Not Applicable</p>
Performance Criteria	As described in the relevant OS units

Definitions	Keywords /Terms	Description
	Sector	Sector is a conglomeration of different business operations having similar businesses and interests. It may also be defined as a distinct subset of the economy whose components share similar characteristics and interests.
	Sub-sector	Sub-sector is derived from a further breakdown based on the characteristics and interests of its components.
	Vertical	Vertical may exist within a sub-sector representing different domain areas or the client industries served by the industry.
	Occupation	Occupation is a set of job roles, which perform similar/related set of functions in an industry.
	Function	Function is an activity necessary for achieving the key purpose of the sector, occupation, or area of work, which can be carried out by a person or a group of persons. Functions are identified through functional analysis and form the basis of OS.
	Sub-functions	Sub-functions are sub-activities essential to fulfill the achieving the objectives of the function.
	Job role	Job role defines a unique set of functions that together form a unique employment opportunity in an organization.
	Occupational Standards (OS)	OS specify the standards of performance an individual must achieve when carrying out a function in the workplace, together with the knowledge and understanding they need to meet that standard consistently. Occupational Standards are applicable both in the Indian and global contexts.
	Performance Criteria	Performance Criteria are statements that together specify the standard of performance required when carrying out a task.
National Occupational Standards (NOS)	NOS are Occupational Standards which apply uniquely in the Indian context.	
Qualifications Pack Code	Qualifications Pack Code is a unique reference code that identifies a qualifications pack.	
Qualifications Pack(QP)	Qualifications Pack comprises the set of OS, together with the educational, training and other criteria required to perform a job role. A Qualifications Pack is assigned a unique qualification pack code.	
Unit Code	Unit Code is a unique identifier for an OS unit, which can be denoted with either an 'O' or an 'N'.	
Unit Title	Unit Title gives a clear overall statement about what the incumbent should be able to do.	
Description	Description gives a short summary of the unit content. This would be	



	helpful to anyone searching on a database to verify that this is the appropriate OS they are looking for.
Scope	Scope is the set of statements specifying the range of variables that an individual may have to deal with in carrying out the function which have a critical impact on the quality of performance required.
Knowledge and Understanding	Knowledge and Understanding are statements which together specify the technical, generic, professional and organizational specific knowledge that an individual needs in order to perform to the required standard.
Organizational Context	Organizational Context includes the way the organization is structured and how it operates, including the extent of operative knowledge managers have of their relevant areas of responsibility.
Technical Knowledge	Technical Knowledge is the specific knowledge needed to accomplish specific designated responsibilities.
Core Skills/Generic Skills	Core Skills or Generic Skills are a group of skills that are key to learning and working in today's world. These skills are typically needed in any work environment. In the context of the OS, these include communication related skills that are applicable to most job roles.
Helpdesk	Helpdesk is an entity to which the customers will report their IT problems. IT Service Helpdesk Attendant is responsible for managing the helpdesk.

Acronyms

Keywords /Terms	Description
IT-ITeS	Information Technology - Information Technology enabled Services
BPM	Business Process Management
BPO	Business Process Outsourcing
KPO	Knowledge Process Outsourcing
LPO	Legal Process Outsourcing
IPO	Information Process Outsourcing
BCA	Bachelor of Computer Applications
B.Sc.	Bachelor of Science
OS	Occupational Standard(s)
NOS	National Occupational Standard(s)
QP	Qualifications Pack
UGC	University Grants Commission
MHRD	Ministry of Human Resource Development
MoLE	Ministry of Labour and Employment
NVEQF	National Vocational Education Qualifications Framework
NVQF	National Vocational Qualifications Framework
NSQF	National Skill Qualification Framework



IT - ITeS SSC  
NASSCOM

NOS  
National Occupational Standards



SSC/N0220

Deal directly with IT services requests/incidents

# National Occupational Standard

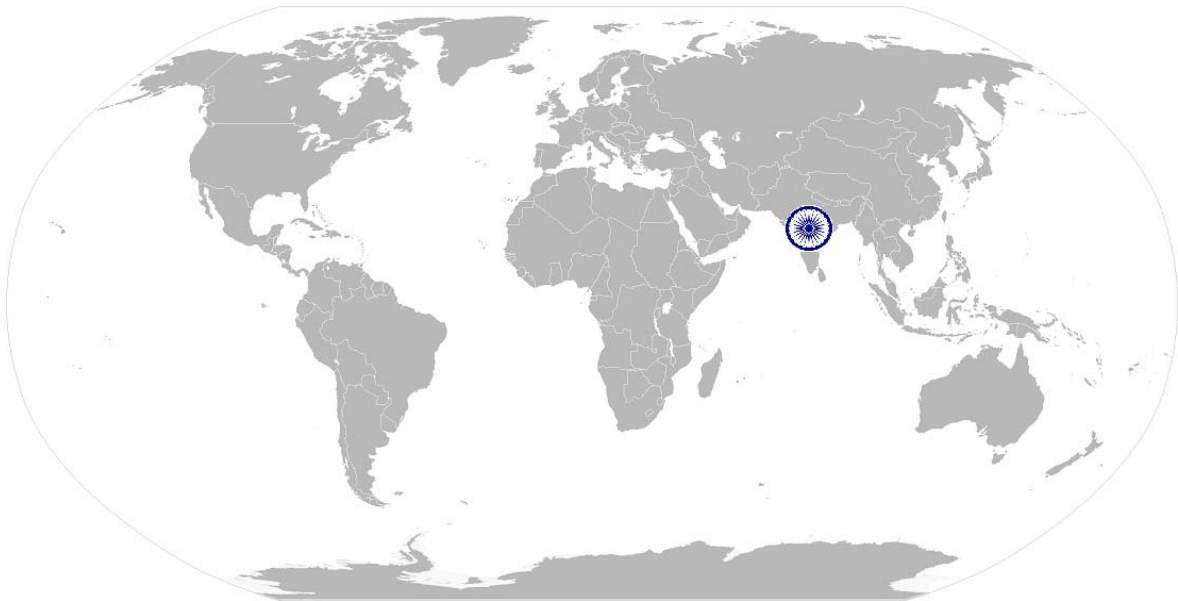

## Overview

This unit is about making telephone calls to customers and prospective customers in order to sell products/services to them.

SSC/N0220

Deal directly with IT services requests/incidents.

Applicable OS Unit

<b>Unit Code</b>	SSC/N0220
<b>Unit Title (Task)</b>	Deal directly with IT service requests/incidents
<b>Description</b>	This unit is about dealing directly with IT service requests and incidents within your level of competence and authority.
<b>Scope</b>	<p>This unit/task covers the following:</p> <p><b>Customers:</b></p> <ul style="list-style-type: none"> <li>• internal</li> <li>• external</li> </ul> <p><b>Incidents</b> may involve:</p> <ul style="list-style-type: none"> <li>• servers</li> <li>• storage</li> <li>• network</li> <li>• databases</li> <li>• applications</li> <li>• security</li> <li>• batch jobs</li> </ul> <p><b>Service requests</b> may include:</p> <ul style="list-style-type: none"> <li>• access management</li> <li>• application installation</li> <li>• peripheral installation</li> <li>• anti-virus installation</li> <li>• security hardening</li> </ul> <p><b>Appropriate people:</b></p> <ul style="list-style-type: none"> <li>• line manager</li> <li>• colleagues</li> <li>• subject matter experts</li> </ul> 
<b>Performance Criteria (PC) w.r.t. the Scope</b>	
	<p>To be competent, you must be able to:</p> <p>PC1. monitor systems to identify promptly automated alerts and <b>customer service requests</b></p> <p>PC2. validate automated alerts to ensure they are genuine <b>incidents</b></p> <p>PC3. record and acknowledge <b>service requests/incidents</b> using your organization's tools and procedures</p> <p>PC4. obtain sufficient information from <b>customers</b> to accurately identify the nature of <b>service requests</b></p> <p>PC5. analyze automated alerts to accurately identify the nature of <b>incidents</b></p> <p>PC6. access your organization's knowledge base to identify solutions/workarounds for <b>service requests/incidents</b></p> <p>PC7. evaluate the suitability of solutions/workarounds, where available</p> <p>PC8. use your organization's guidelines and standard scripts to resolve <b>service requests/incidents</b> within your level of competence and authority</p> <p>PC9. refer <b>service requests/incidents</b> outside your level of competence and authority to <b>appropriate people</b></p>

**SSC/N0220**

**Deal directly with IT services requests/incidents.**

	<p>PC10. obtain help or advice from <b>appropriate people</b>, where necessary</p> <p>PC11. obtain confirmation from <b>customers</b> that <b>service requests/incidents</b> have been resolved</p> <p>PC12. record the resolution of <b>service requests/incidents</b> accurately using your organization's tools and procedures</p> <p>PC13. comply with relevant standards, policies, procedures, guidelines and service level agreements (SLAs) when dealing directly with IT service requests/incidents.</p>
<p><b>Knowledge and Understanding (K)</b></p>	
<p><b>A. Organizational Context</b> (Knowledge of the company/ organization and its processes)</p>	<p>You need to know and understand:</p> <p>KA1. your organization's policies, procedures, guidelines, service level agreements (SLAs) and coding standards for dealing with IT service requests or incidents</p> <p>KA2. different IT applications and the environments in which they are used</p> <p>KA3. the importance of using specific client agreements, SLAs and management plans</p> <p>KA4. the range of methods and techniques, including types of questioning, used when working with customers</p> <p>KA5. the limits of your role and responsibilities in relation to IT service requests/incidents</p> <p>KA6. who to refer problems to when they are outside the limit of your authority</p> <p>KA7. your organization's tools, templates and processes for recording and monitoring service requests and incidents and how to use these</p> <p>KA8. your organization's guidelines and standard scripts for resolving service requests/incidents and how to use these</p> <p>KA9. your organization's knowledge base and how to use and update this</p>
<p><b>B. Technical Knowledge</b></p>	<p>You need to know and understand:</p> <p>KB1. how to access, monitor and validate automated alerts and customer service requests</p> <p>KB2. types of requests or incidents that may occur and how to resolve them</p> <p>KB3. methods and techniques used to identify and evaluate workarounds or new solutions</p> <p>KB4. configuration management and version control techniques for software maintenance/changes</p> <p>KB5. procedures, practices and tools for developing, testing and applying changes to software</p>
<p><b>Skills (S)</b></p>	
<p><b>A. Core Skills/ Generic Skills</b></p>	<p><b>Writing Skills</b></p>
	<p>You need to know and understand how to:</p> <p>SA1. complete accurate well written work with attention to detail</p> <p>SA2. communicate with others in writing</p>
	<p><b>Reading Skills</b></p>
	<p>You need to know and understand how to:</p> <p>SA3. follow guidelines/procedures/rules and service level agreements</p>
	<p><b>Oral Communication (Listening and Speaking skills)</b></p>
<p>You need to know and understand how to:</p>	

SSC/N0220

**Deal directly with IT services requests/incidents.**

	<p>SA4. listen effectively and orally communicate information accurately</p> <p>SA5. ask for clarification and advice from others</p>
<b>B. Professional Skills</b>	<p><b>Decision Making</b></p> <p>You need to know and understand how to:</p> <p>SB1. follow rule-based decision-making processes</p> <p>SB2. identify anomalies in data</p> <p>SB3. make a decision on a suitable course of action or response</p>
	<p><b>Plan and Organize</b></p> <p>You need to know and understand how to:</p> <p>SB4. plan and organize your work to achieve targets and deadlines</p>
	<p><b>Customer Centricity</b></p> <p>You need to know and understand how to:</p> <p>SB5. work effectively in a customer facing environment</p> <p>SB6. carry out rule-based transactions in line with customer-specific guidelines/procedures/rules and service level agreements</p> <p>SB7. check that your own and/or your peers work meets customer requirements</p>
	<p><b>Problem Solving</b></p> <p>You need to know and understand how to:</p> <p>SB8. apply problem-solving approaches in different situations</p> <p>SB9. refer anomalies to the supervisor</p> <p>SB10. seek clarification on problems from others</p>
	<p><b>Analytical Thinking</b></p> <p>You need to know and understand how to:</p> <p>SB11. analyze data and activities</p> <p>SB12. configure data and disseminate relevant information to others</p> <p>SB13. pass on relevant information to others</p>
	<p><b>Critical Thinking</b></p> <p>You need to know and understand how to:</p> <p>SB14. provide opinions on work in a detailed and constructive way</p> <p>SB15. apply balance judgments to different situations</p>
	<p><b>Attention to Detail</b></p> <p>You need to know and understand how to:</p> <p>SB16. apply good attention to detail</p> <p>SB17. check your work is complete and free from errors</p> <p>SB18. get your work checked by others</p>
	<p><b>Team Working</b></p> <p>You need to know and understand how to:</p> <p>SB19. contribute to the quality of team working</p> <p>SB20. work independently in a team environment</p> <p>SB21. work independently and collaboratively</p>
	<p><b>C. Technical Skills</b></p> <p>You need to know and understand how to:</p> <p>SC1. source and use coding standards, ticketing tools and utilities/tools</p> <p>SC2. use information technology effectively to input and/or extract data accurately</p> <p>SC3. identify and refer anomalies in data</p> <p>SC4. store and retrieve information</p>



SSC/N0220

**Deal directly with IT services requests/incidents.**

	<p>SC5. agree objectives and work requirements</p> <p>SC6. keep up to date with changes, procedures and practices in your field of expertise</p>
--	--

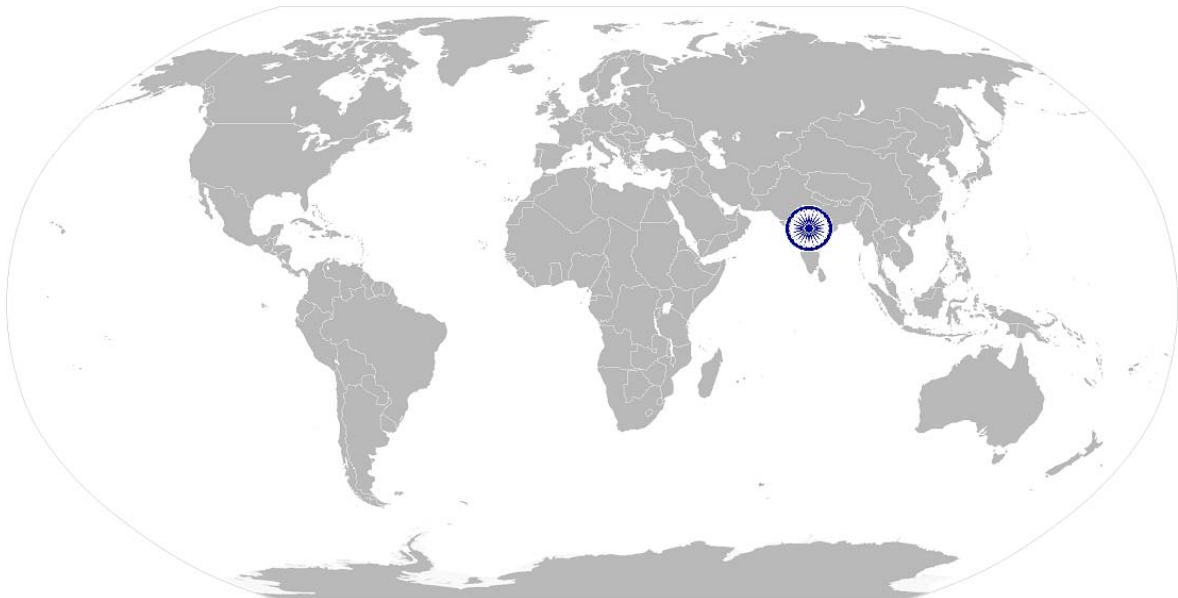

SSC/N0220

Deal directly with IT services requests/incidents.

NOS Version Control

NOS Code	SSC/N0220		
Credits (NSQF) [OPTIONAL]	TBD	Version number	1.0
Industry	IT-ITeS	Drafted on	30/04/2013
Industry Sub-sector	IT Services	Last reviewed on	31/01/2015
		Next review date	31/03/2016

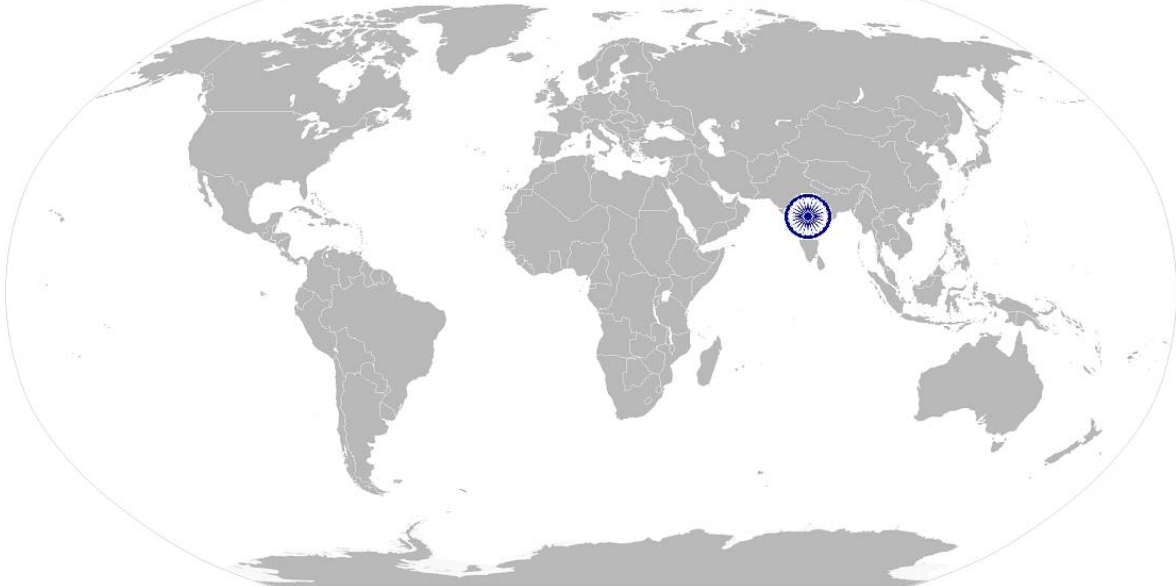



SSC/N9001

NOS  
National Occupational Standards

Manage your work to meet requirements.



# National Occupational Standard

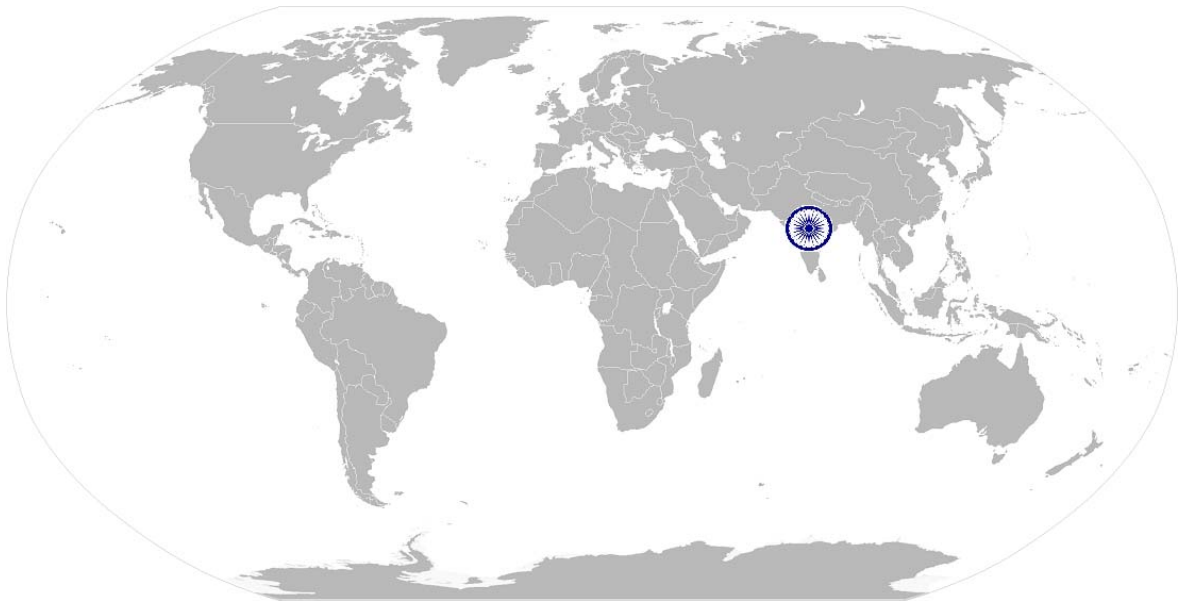

## Overview

This unit is about planning and organizing your work in order to complete it to the required standards on time

**SSC/N9001 Manage your work to meet requirements**

Applicable NOS Unit	<b>Unit Code</b>	SSC/N9001
	<b>Unit Title (Task)</b>	Manage your work to meet requirements
	<b>Description</b>	This unit is about planning and organizing your work in order to complete it to the required standards on time.
	<b>Scope</b>	<p>This unit/task covers the following:</p> <p><b>Work requirements:</b></p> <ul style="list-style-type: none"> <li>• activities (what you are required to do)</li> <li>• deliverables (the outputs of your work)</li> <li>• quantity (the volume of work you are expected to complete)</li> <li>• standards (what is acceptable performance, including compliance with Service Level Agreements)</li> <li>• timing (when your work needs to be completed)</li> </ul> <p><b>Appropriate people:</b></p> <ul style="list-style-type: none"> <li>• line manager</li> <li>• the person requesting the work</li> <li>• members of the team/department</li> <li>• members from other teams/departments</li> </ul> <p><b>Resources:</b></p> <ul style="list-style-type: none"> <li>• equipment</li> <li>• materials</li> <li>• information</li> </ul>
	<b>Performance Criteria (PC) w.r.t. the Scope</b>	
	<p>To be competent on the job, you must be able to:</p> <p>PC1. establish and agree your <b>work requirements</b> with <b>appropriate people</b></p> <p>PC2. keep your immediate work area clean and tidy</p> <p>PC3. utilize your time effectively</p> <p>PC4. use <b>resources</b> correctly and efficiently</p> <p>PC5. treat confidential information correctly</p> <p>PC6. work in line with your organization's policies and procedures</p> <p>PC7. work within the limits of your job role</p> <p>PC8. obtain guidance from <b>appropriate people</b>, where necessary</p> <p>PC9. ensure your work meets the agreed <b>requirements</b></p>	
<b>Knowledge and Understanding (K)</b>		
<b>A. Organizational Context</b> (Knowledge of the company/ organization and its processes)	<p>You need to know and understand:</p> <p>KA1. your organization's policies, procedures and priorities for your area of work and your role and responsibilities in carrying out your work</p> <p>KA2. limits of your responsibilities and when to involve others</p> <p>KA3. your specific work requirements and who these must be agreed with</p> <p>KA4. the importance of having a tidy work area and how to do this</p> <p>KA5. how to prioritize your workload according to urgency and importance and the benefits of this</p>	

**SSC/N9001**

**Manage your work to meet requirements**

	<p>KA6. your organization’s policies and procedures for dealing with confidential information and the importance of complying with these</p> <p>KA7. the purpose of keeping others updated with the progress of your work</p> <p>KA8. who to obtain guidance from and the typical circumstances when this may be required</p> <p>KA9. the purpose and value of being flexible and adapting work plans to reflect change</p>
<p><b>B. Technical Knowledge</b></p>	<p>You need to know and understand:</p> <p>KB1. the importance of completing work accurately and how to do this</p> <p>KB2. appropriate timescales for completing your work and the implications of not meeting these for you and the organization</p> <p>KB3. resources needed for your work and how to obtain and use these</p>
<p><b>Skills (S)</b></p>	
<p><b>A. Core Skills/ Generic Skills</b></p>	<p><b>Writing Skills</b></p> <p>You need to know and understand how to:</p> <p>SA1. complete accurate work with attention to detail</p> <p><b>Reading Skills</b></p> <p>You need to know and understand how to:</p> <p>SA2. read instructions, guidelines, procedures, rules and service level agreements</p> <p><b>Oral Communication (Listening and Speaking skills)</b></p> <p>You need to know and understand how to:</p> <p>SA3. ask for clarification and advice from line managers</p> <p>SA4. communicate orally with colleagues</p>
<p><b>B. Professional Skills</b></p>	<p><b>Decision Making</b></p> <p>You need to know and understand how to:</p> <p>SB1. make a decision on a suitable course of action</p> <p><b>Plan and Organize</b></p> <p>You need to know and understand how to:</p> <p>SB2. plan and organize your work to achieve targets and deadlines</p> <p>SB3. agree objectives and work requirements</p> <p><b>Customer Centricity</b></p> <p>You need to know and understand how to:</p> <p>SB4. deliver consistent and reliable service to customers</p> <p>SB5. check that your own work meets customer requirements</p> <p><b>Problem Solving</b></p> <p>You need to know and understand how to:</p> <p>SB6. refer anomalies to the line manager</p> <p>SB7. seek clarification on problems from others</p> <p><b>Analytical Thinking</b></p>

SSC/N9001

Manage your work to meet requirements

	You need to know and understand how to: SB8. provide relevant information to others SB9. analyze needs, requirements and dependencies in order to meet your work requirements
	<b>Critical Thinking</b>
	You need to know and understand how to: SB10. apply judgments to different situations
	<b>Attention to Detail</b>
	You need to know and understand how to: SB11. check your work is complete and free from errors SB12. get your work checked by peers
	<b>Team Working</b>
	You need to know and understand how to: SB13. work effectively in a team environment
<b>C. Technical Skills</b>	You need to know and understand how to: SC1. use information technology effectively, to input and/or extract data accurately SC2. identify and refer anomalies in data SC3. store and retrieve information SC4. keep up to date with changes, procedures and practices in your role



SSC/N9001  
NOS Version Control

Manage your work to meet requirements

NOS Code	SSC/N9001		
Credits(NVEQF/NVQF/NSQF) [OPTIONAL]	TBD	Version number	1.0
Industry	IT-ITeS	Drafted on	30/04/2013
Industry Sub-sector	Business Process Management	Last reviewed on	31/01/2015
		Next review date	31/03/2016



# National Occupational Standard

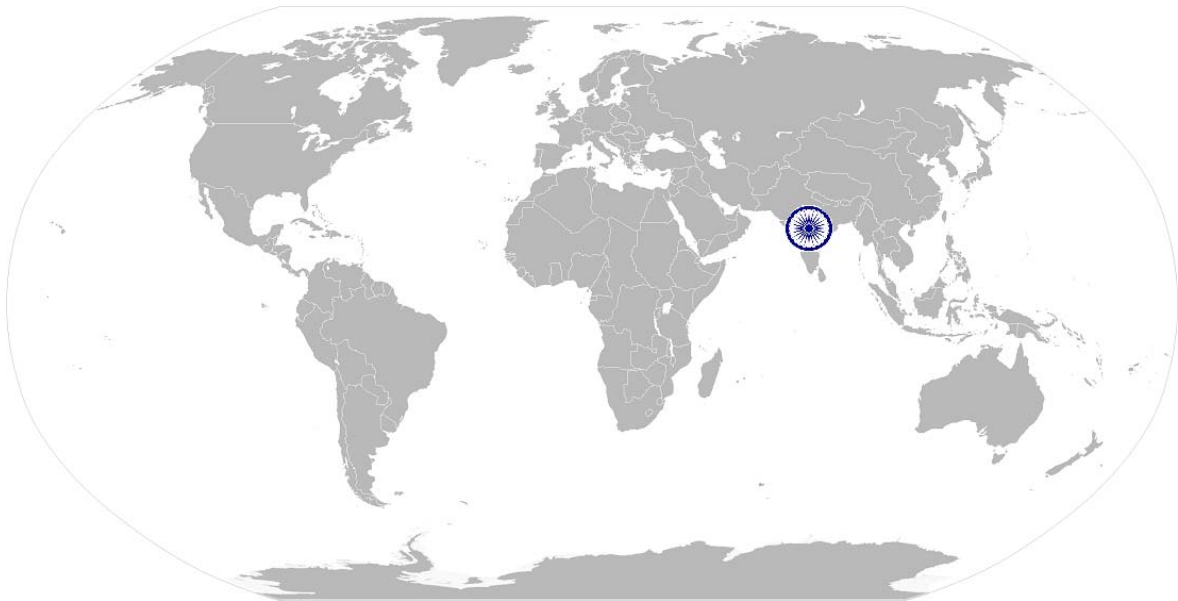

## Overview

This unit is about monitoring the working environment and making sure it meets requirements for health, safety and security.



**SSC/N9003 Maintain a healthy, safe and secure working environment.**

Applicable NOS Unit	<b>Unit Code</b>	SSC/N9003
	<b>Unit Title (Task)</b>	Maintain a healthy, safe and secure working environment
	<b>Description</b>	This unit is about monitoring your working environment and making sure it meets requirements for health, safety and security.
	<b>Scope</b>	<p>This unit/task covers the following:</p> <p><b>Emergency procedures:</b></p> <ul style="list-style-type: none"> <li>• illness</li> <li>• accidents</li> <li>• fires</li> <li>• other reasons to evacuate the premises</li> <li>• breaches of security</li> </ul>
<b>Performance Criteria (PC) w.r.t. the Scope</b>		
		<p>To be competent, you must be able to:</p> <p>PC1. comply with your organization's current health, safety and security policies and procedures</p> <p>PC2. report any identified breaches in health, safety, and security policies and procedures to the designated person</p> <p>PC3. identify and correct any hazards that you can deal with safely, competently and within the limits of your authority</p> <p>PC4. report any hazards that you are not competent to deal with to the relevant person in line with organizational procedures and warn other people who may be affected</p> <p>PC5. follow your organization's <b>emergency procedures</b> promptly, calmly, and efficiently</p> <p>PC6. identify and recommend opportunities for improving health, safety, and security to the designated person</p> <p>PC1. complete any health and safety records legibly and accurately</p>
<b>Knowledge and Understanding (K)</b>		
<b>A. Organizational Context</b> (Knowledge of the company/ organization and its processes)		<p>You need to know and understand:</p> <p>KA1. legislative requirements and organization's procedures for health, safety and security and your role and responsibilities in relation to this</p> <p>KA2. what is meant by a hazard, including the different types of health and safety hazards that can be found in the workplace</p> <p>KA3. how and when to report hazards</p> <p>KA4. limits of your responsibility for dealing with hazards</p> <p>KA5. your organization's <b>emergency procedures</b> for different emergency situations and the importance of following these</p> <p>KA6. the importance of maintaining high standards of health, safety and security</p> <p>KA7. implications that any non-compliance with health, safety and security may have on individuals and the organization</p>

**SSC/N9003 Maintain a healthy, safe and secure working environment.**

<p><b>B. Technical Knowledge</b></p>	<p>You need to know and understand:</p> <p>KB1. different types of breaches in health, safety and security and how and when to report these</p> <p>KB2. evacuation procedures for workers and visitors</p> <p>KB3. how to summon medical assistance and the emergency services, where necessary</p> <p>KB4. how to use the health, safety and accident reporting procedures and the importance of these</p> <p>KB5. government agencies in the areas of safety, health and security and their norms and services</p>
<p><b>Skills (S)</b></p>	
<p><b>A. Core Skills/ Generic Skills</b></p>	<p><b>Writing Skills</b></p> <p>You need to know and understand how to:</p> <p>SA1. complete accurate, well written work with attention to detail</p> <p><b>Reading Skills</b></p> <p>You need to know and understand how to:</p> <p>SA2. read instructions, guidelines, procedures, rules and service level agreements</p> <p><b>Oral Communication (Listening and Speaking skills)</b></p> <p>You need to know and understand how to:</p> <p>SA3. listen effectively and orally communicate information accurately</p>
<p><b>B. Professional Skills</b></p>	<p><b>Decision Making</b></p> <p>You need to know and understand how to:</p> <p>SB1. make a decision on a suitable course of action</p> <p><b>Plan and Organize</b></p> <p>You need to know and understand how to:</p> <p>SB2. plan and organize your work to meet health, safety and security requirements</p> <p><b>Customer Centricity</b></p> <p>You need to know and understand how to:</p> <p>SB3. build and maintain positive and effective relationships with colleagues and customers</p> <p><b>Problem Solving</b></p> <p>You need to know and understand how to:</p> <p>SB4. apply problem solving approaches in different situations</p> <p><b>Analytical Thinking</b></p> <p>You need to know and understand how to:</p> <p>SB5. analyze data and activities</p> <p><b>Critical Thinking</b></p> <p>You need to know and understand how to:</p> <p>SB6. apply balanced judgments to different situations</p>

**SSC/N9003 Maintain a healthy, safe and secure working environment.**

	<b>Attention to Detail</b>
	You need to know and understand how to: SB7. check your work is complete and free from errors SB8. get your work checked by peers
	<b>Team Working</b>
	You need to know and understand how to: SB9. work effectively in a team environment
<b>C. Technical Skills</b>	You need to know and understand how to: SC1. identify and refer anomalies SC2. help reach agreements with colleagues SC3. keep up to date with changes, procedures and practices in your role

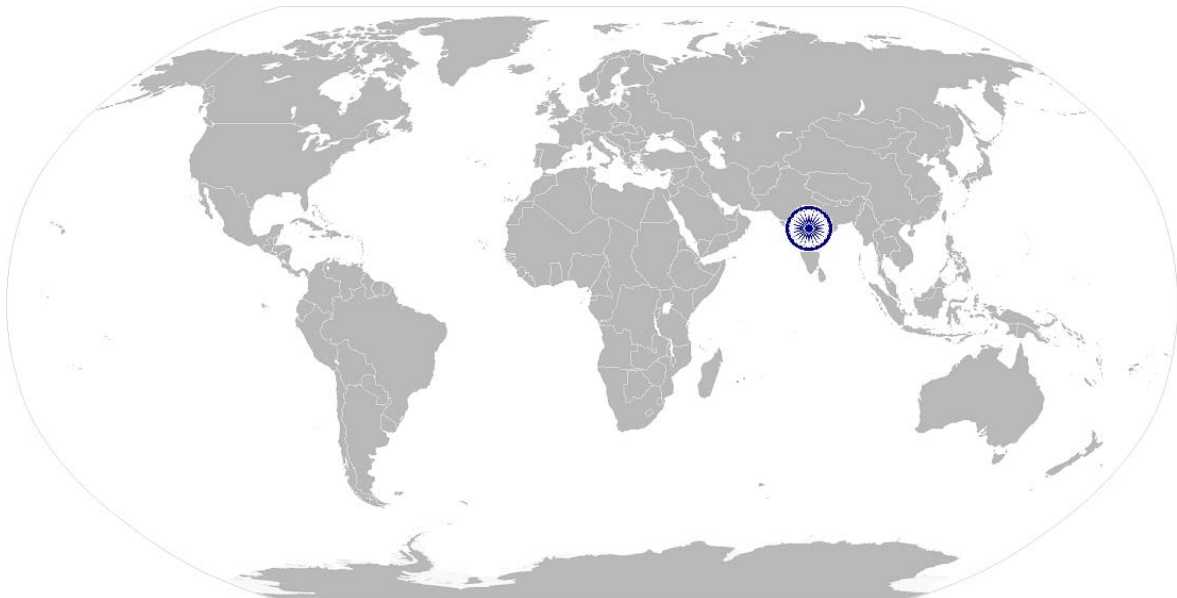

**SSC/N9003 Maintain a healthy, safe and secure working environment.**  
**NOS Version Control**

<b>NOS Code</b>	<b>SSC/N9003</b>		
<b>Credits(NVEQF/NVQF/NSQF) [OPTIONAL]</b>	<b>TBD</b>	<b>Version number</b>	<b>1.0</b>
<b>Industry</b>	<b>IT-ITeS</b>	<b>Drafted on</b>	<b>30/04/2013</b>
<b>Industry Sub-sector</b>	<b>Business Process Management</b>	<b>Last reviewed on</b>	<b>31/01/2015</b>
		<b>Next review date</b>	<b>31/03/2016</b>

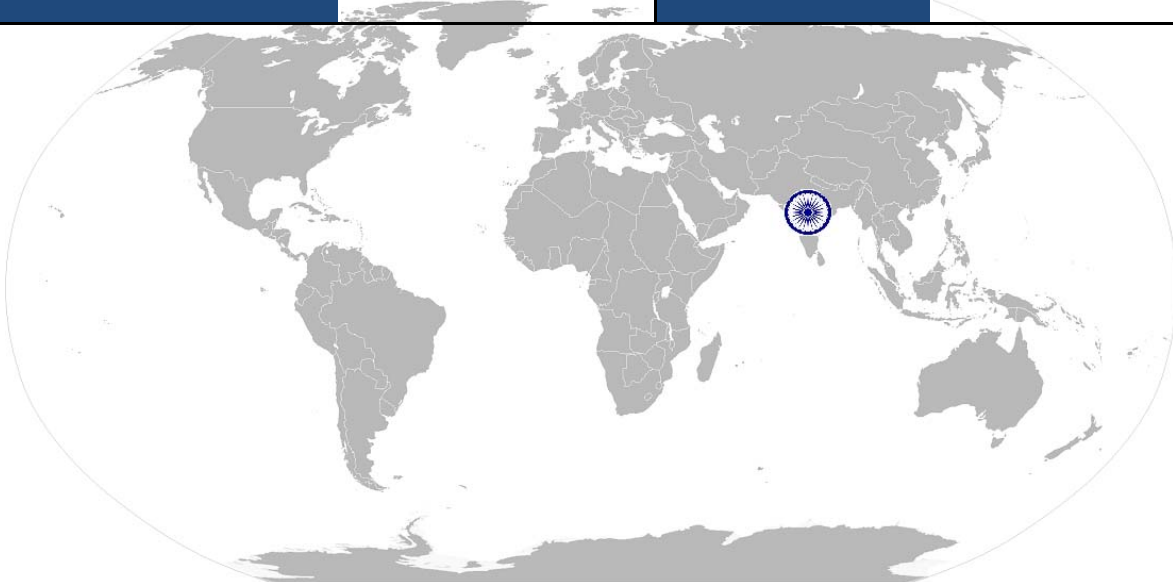

Nomenclature for QP and NOS Units

**Qualifications Pack**

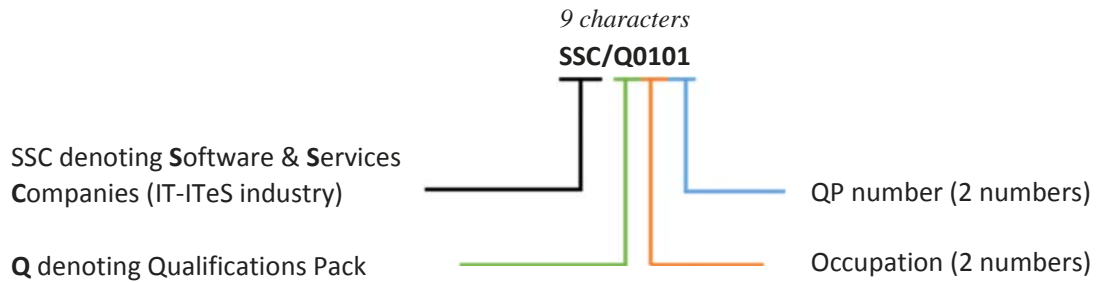

**National Occupational Standard**

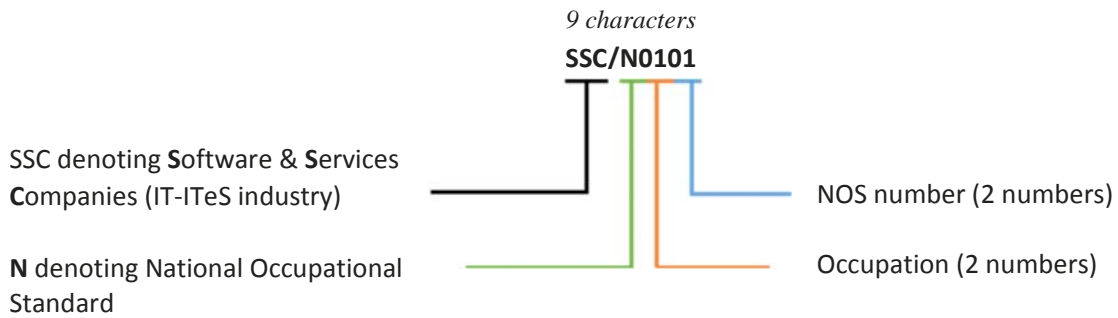

**Occupational Standard**

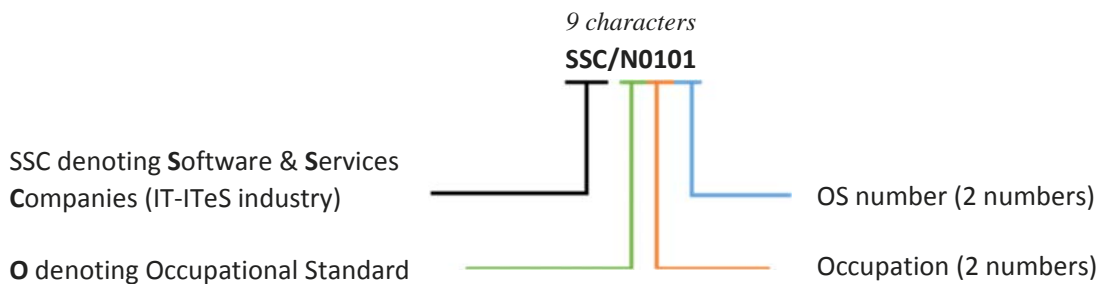

It is important to note that an OS unit can be denoted with either an 'O' or an 'N'.

- If an OS unit denotes 'O', it is an OS unit that is an international standard. An example of OS unit denoting 'O' is SSC/O0101.
- If an OS unit denotes 'N', it is an OS unit that is a national standard and is applicable only for the Indian IT-ITeS industry. An example of OS unit denoting 'N' is SSC/N0101

*Nomenclature for QP and NOS Units*

The following acronyms/codes have been used in the nomenclature above:

Sub-Sector	Range of Occupation numbers
IT Service (ITS)	01-20
Business Process Management (BPM)	21-40
Engg. and R&D (ERD)	41-60
Software Products (SPD)	61-80

Sequence	Description	Example
Three letters	Industry name (Software & Service Companies )	SSC
Slash	/	/
Next letter	Whether QP or NOS	N
Next two numbers	Occupation Code	01
Next two numbers	OS number	01

*Criteria for Assessment of Trainees*

<b><u>Job Role</u></b>	Domestic IT Helpdesk Attendant
<b><u>Qualification Pack</u></b>	SSC/Q0110
<b><u>Sector Skill Council</u></b>	IT-ITeS

**Guidelines for Assessment:**

1. Criteria for assessment for each Qualification Pack (QP) will be created by the Sector Skill Council (SSC). Each performance criteria (PC) will be assigned Theory and Skill/Practical marks proportional to its importance in NOS.
2. The assessment will be conducted online through assessment providers authorised by SSC.
3. Format of questions will include a variety of styles suitable to the PC being tested such as multiple choice questions, fill in the blanks, situational judgment test, simulation and programming test.
4. To pass a QP, a trainee should pass each individual NOS. Standard passing criteria for each NOS is 70%.
5. For latest details on the assessment criteria, please visit [www.sscnasscom.com](http://www.sscnasscom.com).

		Marks Allocation			
		Total Mark	Out of	Theory	Skills Practical
<b>1. SSC/N0220 (Deal directly with IT service requests/incidents)</b>	PC1. monitor systems to identify promptly automated alerts and customer service requests	<b>120</b>	5	0	5
	PC2. validate automated alerts to ensure they are genuine incidents		5	0	5
	PC3. record and acknowledge service requests/incidents using your organization's tools and procedures		5	0	5
	PC4. obtain sufficient information from customers to accurately identify the nature of service requests		7.5	2.5	5
	PC5. analyze automated alerts to accurately identify the nature of incidents		10	0	10
	PC6. access your organization's knowledge base to identify solutions/workarounds for service requests/incidents		10	0	10
	PC7. evaluate the suitability of solutions/workarounds, where available		5	0	5
	PC8. use your organization's guidelines and standard scripts to resolve service requests/incidents within your level of competence and authority		5	0	5
	PC9. refer service requests/incidents		5	0	5

*Criteria for Assessment of Trainees*

	outside your level of competence and authority to appropriate people				
	PC10. obtain help or advice from appropriate people, where necessary		5	0	5
	PC11. obtain confirmation from customers that service requests/incidents have been resolved		7.5	2.5	5
	PC12. record the resolution of service requests/incidents accurately using your organization's tools and procedures		35	15	20
	PC13. comply with relevant standards, policies, procedures, guidelines and service level agreements (SLAs) when dealing directly with IT service requests/incidents.		15	0	15
		<b>Total</b>	<b>120</b>	<b>20</b>	<b>100</b>
<b>2.SSC/N9001 (Manage your work to meet requirements)</b>	PC1. establish and agree your work requirements with appropriate people		10	5	5
	PC2. keep your immediate work area clean and tidy		5	0	5
	PC3. utilize your time effectively		5	5	0
	PC4. use resources correctly and efficiently		5	2.5	2.5
	PC5. treat confidential information correctly	<b>40</b>	5	0	5
	PC6. work in line with your organization's policies and procedures		2.5	0	2.5
	PC7. work within the limits of your job role		2.5	0	2.5
	PC8. obtain guidance from appropriate people, where necessary		2.5	0	2.5
	PC9. ensure your work meets the agreed requirements		2.5	0	2.5
		<b>Total</b>	<b>40</b>	<b>12.5</b>	<b>27.5</b>
<b>4.SSC/N9003 (Maintain a healthy, safe and secure working environment)</b>	PC1. comply with your organization's current health, safety and security policies and procedures		10	5	5
	PC2. report any identified breaches in health, safety, and security policies and procedures to the designated person		5	0	5
	PC3. identify and correct any hazards that you can deal with safely, competently and within the limits of your authority	<b>40</b>	10	5	5
	PC4. report any hazards that you are not competent to deal with to the relevant person in line with organizational procedures and warn other people who may be affected		5	0	5
	PC5. follow your organization's emergency procedures promptly, calmly, and efficiently		5	0	5
	PC6. identify and recommend opportunities for improving health, safety, and security to the		2.5	0	2.5



*Criteria for Assessment of Trainees*

	designated person				
	PC7. complete any health and safety records legibly and accurately		2.5	0	2.5
		<b>Total</b>	40	10	30