

Date code: YWWD  
 Y=Year, 0~9  
 WW=Week, 1~52  
 D=Day, 1~7

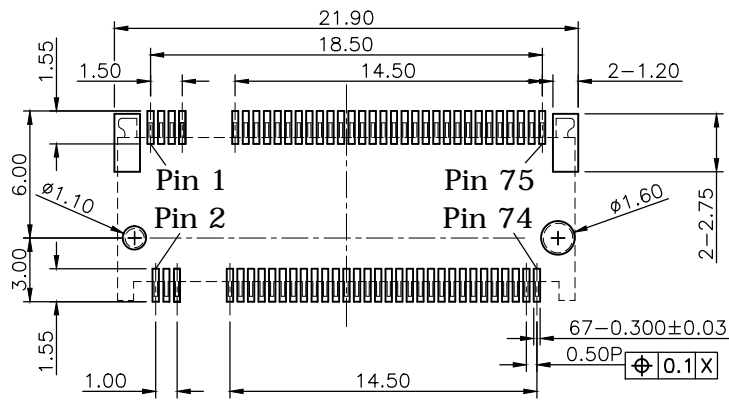

Recommended Layout (Top View)  
 General Tolerance: ±0.05mm

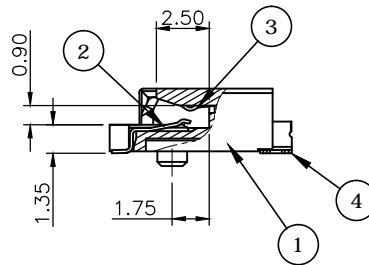
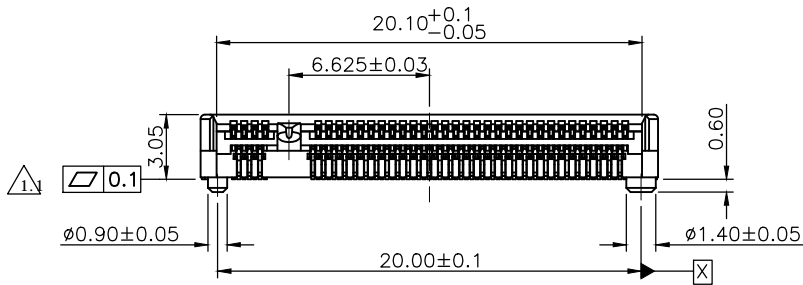
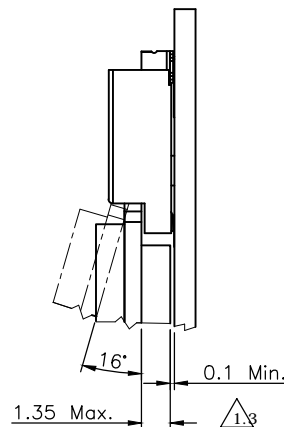

REV.	DESCRIPTION	DRAWN	DATE
1.1	Add flatness tolerance	FROS	2019/08/07
1.2	Corrected temperature to 85°C	FROS	2019/08/15
1.3	Added M.2 module thickness & related space height	FROS	2019/08/29

**SPECIFICATION:**

**1. ELECTRICAL**

- 1.1 Current Rating: 0.5A per pin
- 1.2 Voltage Rating: 50VAC
- 1.3 Contact Resistance: 50mΩ
- 1.4 Insulation Resistance: 500MΩ
- 1.5 Dielectric Withstanding Voltage: 300VAC

**2. MECHANICAL**

- 2.1 Durability: 60 Cycle
- 2.2 Mating Force: 20N max.
- 2.3 Un-mating Force: 25N max.

**3. ENVIRONMENTAL**

- 3.1 Operating temperature range: -40°C~+85°C
- 3.2 Storage temperature range: -40°C~+85°C

**4. SOLDER ABILITY**

- 4.1 Recommended IR Reflow (Wave Soldering) Temperature: 260°C

4	HOLD DOWN	BRASS, C2680R-H, 100u" Matte Tin plated, under-plated Nickel 50u"
3	LOWER CONTACT	PHOSPHOR BRONZE, C5210R-EH
2	UPPER CONTACT	Contact area: Gold flash, Solder area: Gold flash, all under-plated Nickel 50u"
1	INSULATOR	LCP, UL94V-0, BLACK
NO.	PART NAME	DESCRIPTION

UNLESS OTHERWISE SPECIFIED TOLERANCE

UNIT:	DECIMAL	LINEAR	ANGLES
mm	X.	±0.50	±5°
	X.X	±0.25	±3°
	X.XX	±0.12	±1°



WWW.ATTEND.COM.TW

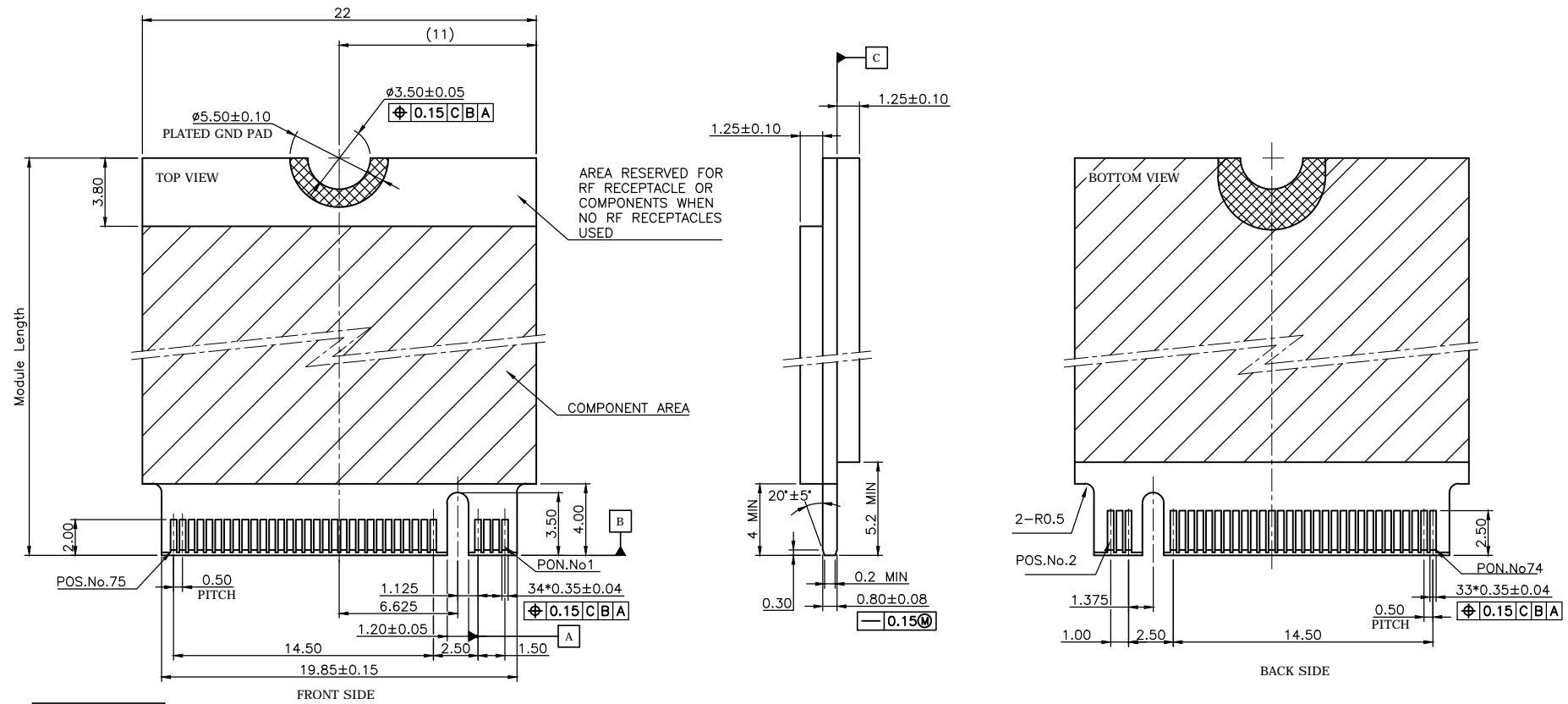

DRAWN	Fros	2018/12/06	DRAWN NAME:	M.2 Socket, H3.0 A Key	
CHECKED	Tim	2018/12/06		0.5 Pitch G/F, Black, Reel	
APPROVED	Ken	2018/12/06	PRODUCT NO.	123A-30A00	
SCALE	2.8	SHEET	1/1	SIZE	A4
FILE NAME	123A-30A00_B_1.3				

REV.	DESCRIPTION	DRAWN	DATE
1	INITIAL RELEASE	FROS	2019/01/09
1.1	Corrected	FROS	2019/09/11



Module Length (mm)
42
60
80
110

KEY ID "A"  
RECOMMENDED MODULE LAYOUT

UNLESS OTHERWISE SPECIFIED TOLERANCE					
UNIT:	DECIMAL	LINEAR	ANGLES		
mm	X.	±0.50	±5°	www.attend.com.tw	
	X.X	±0.25	±3°		
	X.XX	±0.12	±1°		
DRAWN	Fros	2019/01/09	DRAWN NAME:		
CHECKED	Tim	2019/01/09	PCI Express M.2 Specification Module Dimensions		
APPROVED	Ken	2019/01/09	PRODUCT NO.	N/A	
	SCALE 2.8	SHEET 1/4	SIZE A4	FILE NAME	123A-CARD_B_1.1

REV.	DESCRIPTION	DRAWN	DATE
1	INITIAL RELEASE	TIM	2018/01/19



**PACKAGING SPECIFICATION:**

1. MATERIAL
  - 1.1 Embossed Carrier Tape: PS Black
  - 1.2 Top Cover Tape: PET  
20-80g(Peel Speed 300mm/Minute)
  - 1.3 Taping Reel: Plastic

2. Packaging:

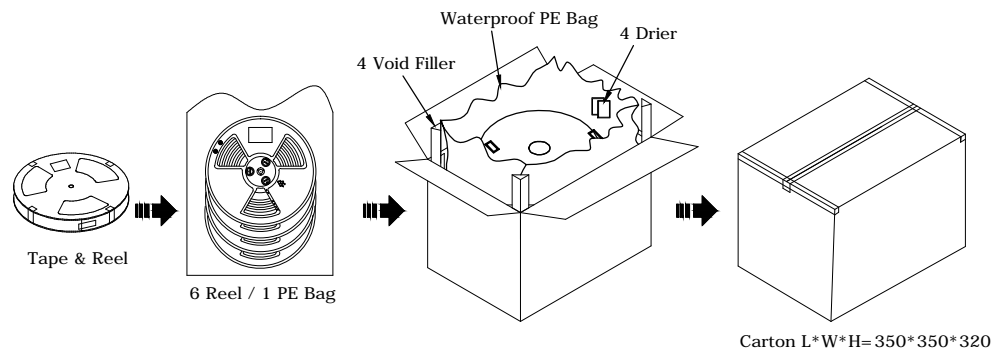
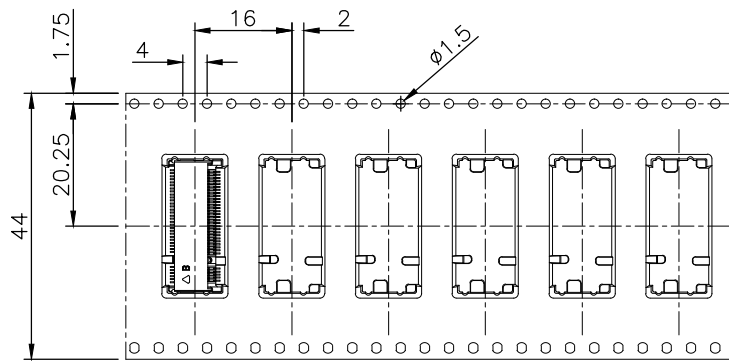
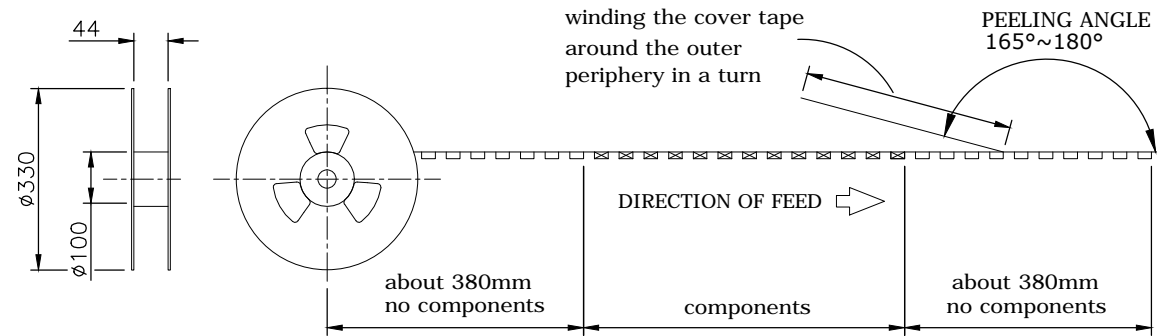
P/N	Height	Reel	Carton
123A-21X00	2.15	1200	7200
123A-30X00	3.05	900	5400
123A-40X00	4.05	700	4200
123A-58X00	5.80	600	3600



UNLESS OTHERWISE SPECIFIED TOLERANCE					
UNIT:	DECIMAL	LINEAR	ANGLES		
mm	X.	±0.50	±5°	WWW.ATTEND.COM.TW	
	X.X	±0.25	±3°		
	X.XX	±0.12	±1°		
DRAWN	Tim	2018/01/19	DRAWN NAME: M.2 CONNECTOR PACKAGING		
CHECKED	Fros	2018/01/19			
APPROVED	Ken	2018/01/19	PRODUCT NO.	123A-XXX00	
	SCALE 0.8	SHEET 1/1	SIZE A4	FILE NAME	123A-XXX00_D_1

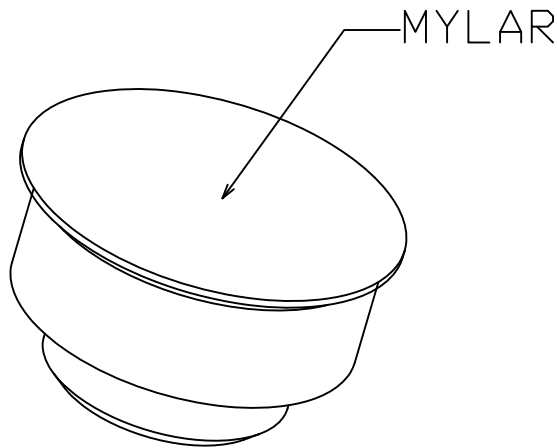
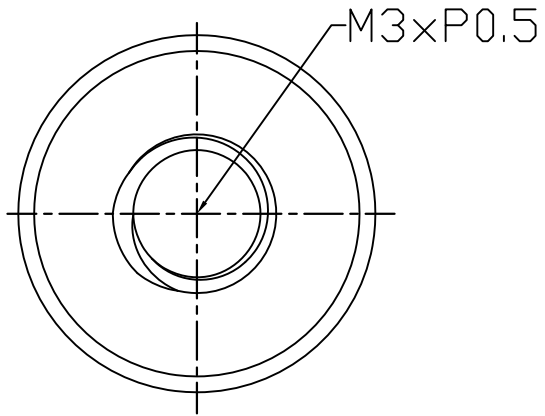

NOTE:

- 1.MATERIAL: Copper Alloy
- 2.Plating: Sn.

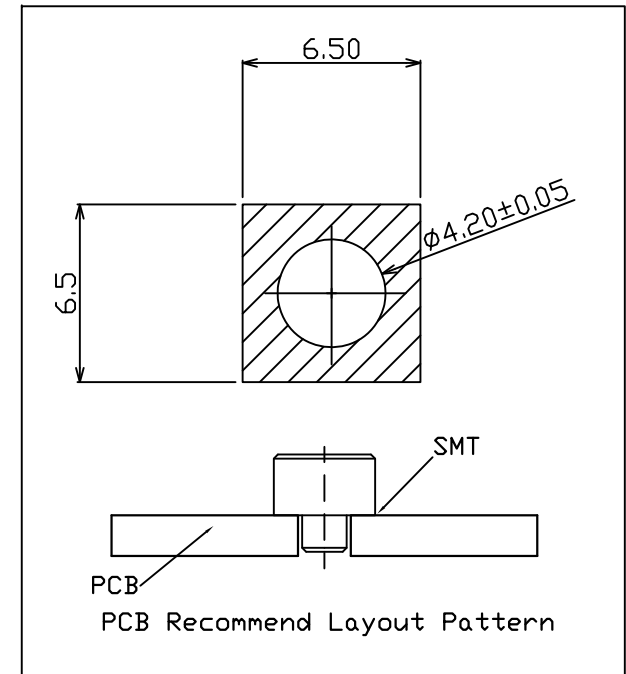
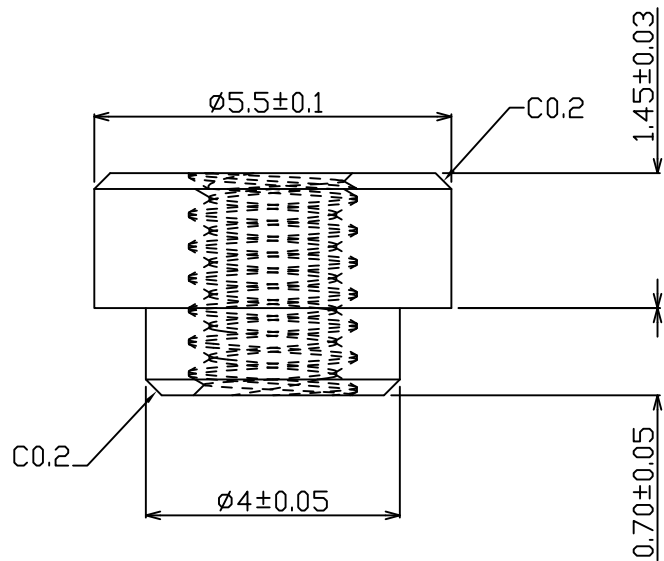

REV.	DESCRIPTION	DATE	REV.	DESCRIPTION	DATE	UNLESS OTHERWISE SPECIFIED TOLERANCE	www.attend.com.tw	
						ANGLES	ANG.	$\pm 5^\circ$
							0.	$\pm 0.3$
						LINEAR	0.0	$\pm 0.25$
							0.00	$\pm 0.20$
						SCALE	AS SHOWN	UNIT: mm
A	Revise:					DRAWN	Willis	2013/08/06
	Revise:					CHECKED	Angel	2013/08/06
	Revise:					APPROVED	Ken	2013/08/06
						SIZE	A4	REV. 1.0
						FILE NAME	123A-NUT-32_B_1	



www.attend.com.tw  
 DRAWN NAME: M.2 Connector Stand Off  
 PRODUCT NO. 123A-NUT-32  
 FILE NAME 123A-NUT-32\_B\_1

$\phi 5.5^{+0}_{-0.5}$

#1

$\phi 5.5^{+0}_{-0.5}$

$0.8 \pm 0.1$

$2.5^{+0}_{-0.3}$

M3.0\*P0.50

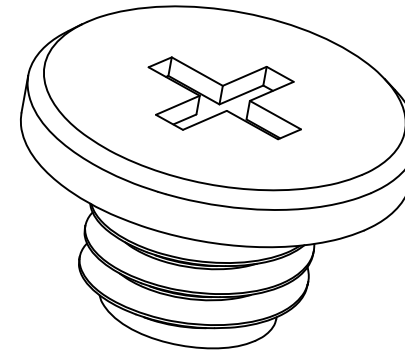

Note:  
 1.Material: Low-carbon steel  
 2.Plating: Nickel

UNLESS OTHERWISE SPECIFIED TOLERANCE		
ANGLES	ANG.	±5°
LINEAR	0.	±0.3
	0.0	±0.25
	0.00	±0.20
SCALE	AS SHOWN	UNIT: mm
DRAWN	Willis	2013/08/06
CHECKED	Angel	2013/08/06
APPROVED	Ken	2013/08/06



www.attend.com.tw

REV.	DESCRIPTION	DATE	REV.	DESCRIPTION	DATE
1					
2					
3					
4					
5					
6					
7					

A ⚠ Revise: ⚠ Revise: ⚠ Revise:	DRAWN NAME: M.2 Series Screw PRODUCT NO. 123A-SCREW FILE NAME 123A-SCREW_B_1
--	---

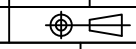

SIZE A4

REV. 1.0

FILE NAME 123A-SCREW\_B\_1