

REV.	DESCRIPTION	DRAWN	DATE
3	REVISED PN TABLE LIST	Tim	2016/07/11
4	ECR1800007, SPACER material Nylon -> LCP	Fros	2018/04/03
5	ECR1900014	Fros	2019/08/06

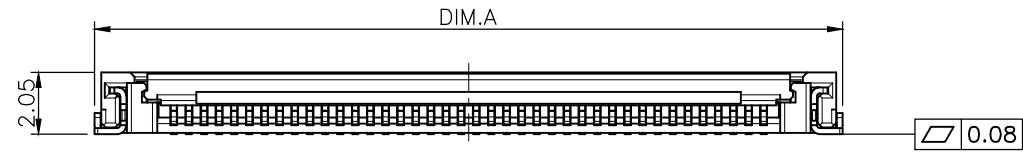

All contacts & latch must be coplanar within 0.08mm

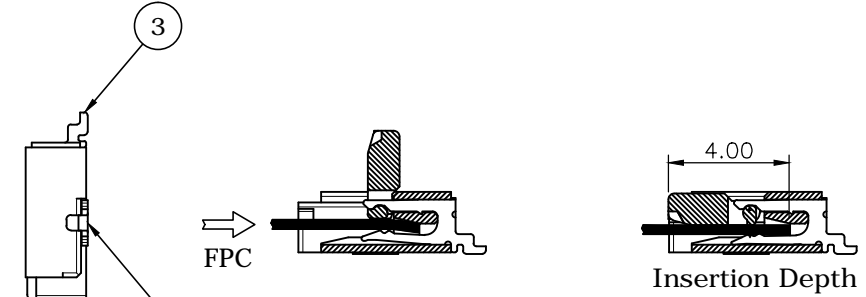
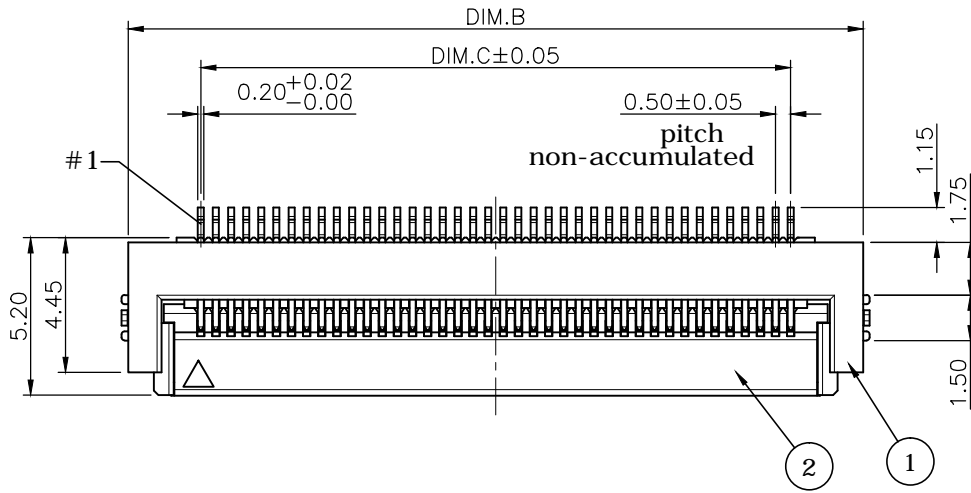
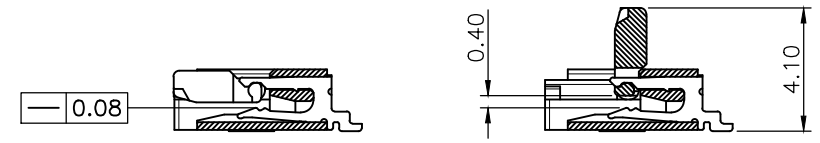

All contacts point be coplanar within 0.08mm

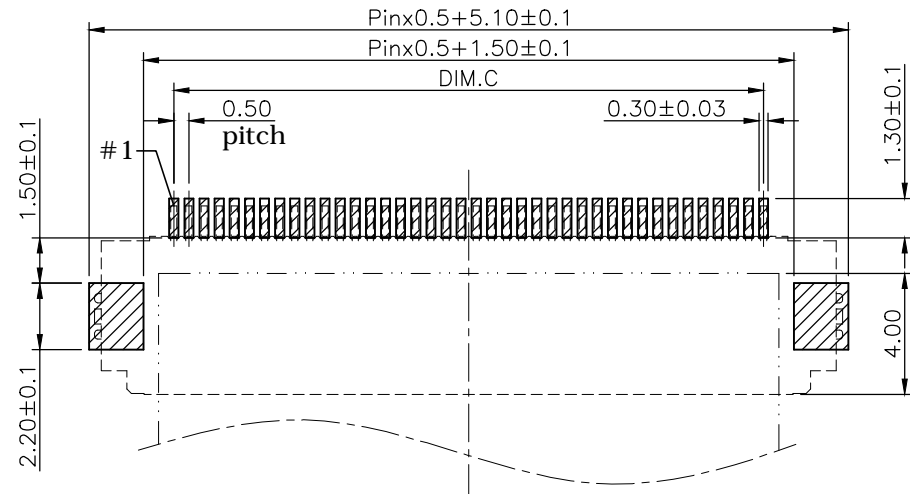

RECOMMENDED LAYOUT (TOP VIEW)  
GENERAL TOLERANCE: ±0.05mm

4	HOLD DOWN	Brass C2680R-H, Gold Flash & over Nickel 50 to 150u" under-plating
3	CONTACT	Phosphor Bronze C5191R-H, Gold Flash & over Nickel 50 to 150u" under-plating
2	SPACER	LCP UL94V-0, Natural color
1	INSULATOR	LCP UL94V-0, Natural color
NO.	PART NAME	DESCRIPTION

UNLESS OTHERWISE SPECIFIED TOLERANCE			
UNIT:	DECIMAL	LINEAR	ANGLES
mm	X.	±0.50	±5°
	X.X	±0.25	±3°
	X.XX	±0.12	±1°



DRAWN	Willis	2012/08/03	DRAWN NAME:	FPC Connector Horizontal Type
CHECKED	Angel	2012/08/03		Pitch: 0.5mm Thickness: 2.0mm
APPROVED	Ken	2012/08/03	PRODUCT NO.	See Page 2
SCALE	4/1	SHEET	1/2	SIZE
				A4
FILE NAME		314A-XXBAA-R_B_5		

REV.	DESCRIPTION	DRAWN	DATE
	see sheet one		

Dimension table of connector				
POS.	DIM.A	DIM.B	DIM.C	DIM.D
8	8.75	8.30	3.50	4.50
10	9.75	9.30	4.50	5.50
12	10.75	10.30	5.50	6.50
16	12.75	12.30	7.50	8.50
18	13.75	13.30	8.50	9.50
20	14.75	14.30	9.50	10.50
22	15.75	15.30	10.50	11.50
24	16.75	16.30	11.50	12.50
26	17.75	17.30	12.50	13.50
30	19.75	19.30	14.50	15.50
32	20.75	20.30	15.50	16.50
33	21.25	20.80	16.00	17.00
40	24.75	24.30	19.50	20.50
45	27.25	26.80	22.00	23.00
50	29.75	29.30	24.50	25.50
54	31.75	31.30	26.50	27.50
55	32.25	31.80	27.00	28.00

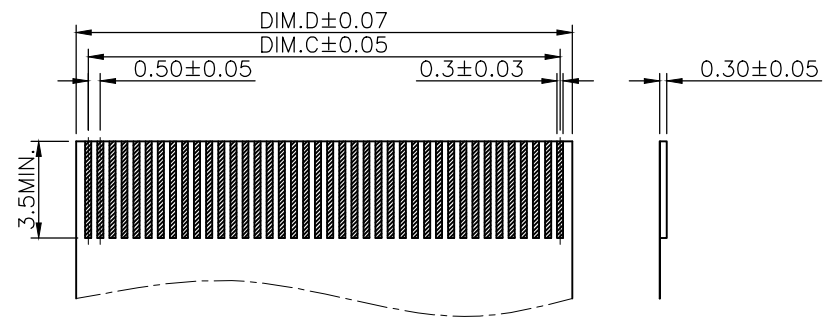

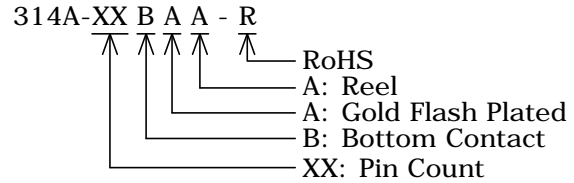

**FPC LAYOUT**  
**SCALE 3.2/1**

**HOW TO ORDER:**



(Please contact with sales for the pins count available)

UNLESS OTHERWISE SPECIFIED TOLERANCE				 WWW.ATTEND.COM.TW
UNIT:	DECIMAL	LINEAR	ANGLES	
mm	X.	±0.50	±5°	
	X.X	±0.25	±3°	
	X.XX	±0.12	±1°	
DRAWN	Willis	2012/08/03	DRAWN NAME:	
CHECKED	Angel	2012/08/03	FPC Connector Horizontal Type Pitch: 0.5mm Thickness: 2.0mm	
APPROVED	Ken	2012/08/03	PRODUCT NO.	See how to order
	SCALE	SHEET	SIZE	FILE NAME
	1/1	2/2	A4	314A-XXBAA-R_B_5